



ORLEANS STEEL

BUILDING MATERIAL

1641 POLAND AVENUE
NEW ORLEANS, LA 70117
WWW.ORLEANSSTEEL.COM
504.381.5790

CATALOG

PRICE



GATES

Gate Type 1 **\$189.00**

Size : 46" H x 42.5" W
 Door Frame : 1 1/2*1 1/2in*11GA
 Cross Bar : 1 1/2*3/4in, 18GA
 Vertical Bar : 3/4*3/4in, 16GA; Gap 4in
 Material : Galvanized material, the powder coated black color
 Cap: 9

Gate Type 2 **\$211.00**

Size : 70" H x 42.5" W
 Door Frame : 1 1/2*1 1/2in*11GA
 Cross Bar : 1 1/2*3/4in, 18GA
 Vertical Bar : 3/4*3/4in, 16GA; Gap 4in
 Material : Galvanized material, the powder coated black color
 Cap: 9



Gate Type 3 **\$275.00**

Size : 70" H x 66.5" W
 Door Frame : 1 1/2*1 1/2in*11GA
 Cross Bar : 1 1/2*3/4in, 18GA
 Vertical Bar : 3/4*3/4in, 16GA; Gap 4in
 Material : Galvanized material, the powder coated black color
 Cap: 16

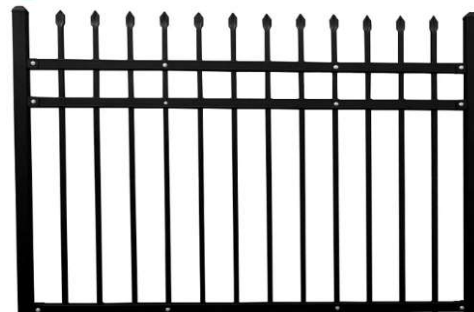

Gate Type 4 (Pair) **\$659.00**

Size : 70" H(lowest), 82" H(highest) x 60" W (per panel)
 Door Frame : 1 1/2*1 1/2in*11GA
 Cross Bar : 1 1/2*3/4in, 18GA
 Vertical Bar : 3/4*3/4in, 16GA; Gap 4in
 Material : Galvanized material, the powder coated black color
 Cap: 14/28



Gate Type

Size : 90" H x 42.5" W
 Door Frame :
 Cross Bar :
 Vertical Bar :
 Material :
 Cap:



COMING SOON

FENCES

Fence Type 1 **\$129.00**

Size : 46" H x 91.5" W
Cross Bar : 1 1/2*3/4in, 18GA
Vertical Bar : 3/4*3/4in, 16GA; Gap 4in
Material : Galvanized material, the powder coated black color
Cap: 23

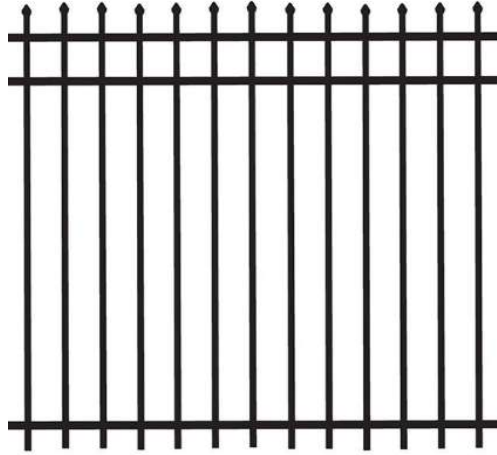

Fence Type 2 **\$166.00**

Size : 70" H x 91.5" W
Cross Bar : 1 1/2*3/4in, 18GA
Vertical Bar : 3/4*3/4in, 16GA; Gap 4in
Material : Galvanized material, the
Cap: 23

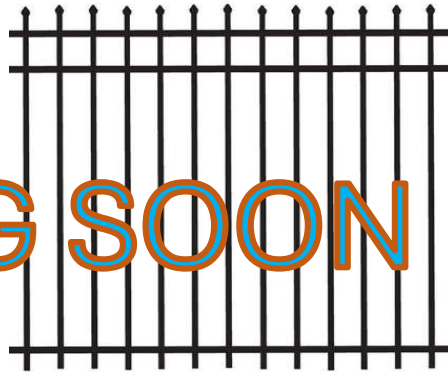

Fence Type 3

Size : 90"W x 90"H
Cross Bar :
Vertical Bar :
Material :
Cap:

COMING SOON

ACCESSORIES

Fence Post - 11Ga



2x2x72	\$28.80	3x3x72	\$40.80	4x4x192	\$115.44
2x2x96	\$38.40	3x3x96	\$53.52	4x4x236	\$144.30
2x2x192	\$62.40	3x3x192	\$94.56		
2x2x236	\$78.00	3x3x236	\$118.20		

Ornament
Fleur de Lis



\$2.16

Fence Bracket
w/ Screw



\$0.99

Post Plate



Sizes

4x4	\$2.00
5x5	\$3.00
6x6	\$4.00

Post Cap

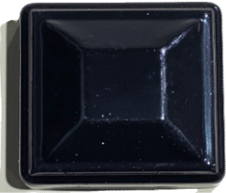

Sizes

2x2	\$1.50
3x3	\$2.00
4x4	\$3.00



3/4x3/4

2x2	
3x3	
4x4	

Ball Cap Black / Galvanize



3/4x3/4

3/4x3/4	\$0.75
2x2	\$2.00
3x3	\$3.00
4x4	\$4.00

Gate Latch \$8.00



Cane Bolt \$19.99



Colors

- Black
- Stainless Steel

L-Bracket \$0.55

2x2



Heavy Duty

Gate Hinge - 6" \$24.99



Heavy Duty

Gate Wheel - 4" \$39.99



Wedge Hinge \$1.25



ANCHORS

Wedge Anchor Bolt

1/2-13 x 5 1/2" \$1.25

Stainless Steel / Zinc



3/4 x 5 1/2" \$2.99

Zinc



3/8 x 3" \$0.97

Zinc

Mobile Home \$6.89

Size: 5/8" x 30" W/ nut



Asphalt \$6.89

Size: 5/8" x 30" W/ 1 bolt, 1 nut, 2 washers



Rebar \$2.80

Size: 30" x .5"Dia



R-PANELS

R-Panel roofing is a metal roof made of 36" metal panels that have raised ribs with a flat area between the ribs. R-Panel is used in both residential and commercial applications and can also be used as siding.

Low Profile

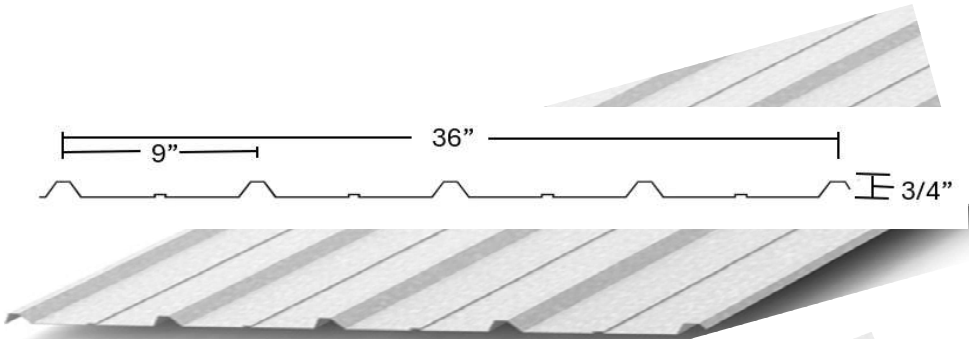

High Profile

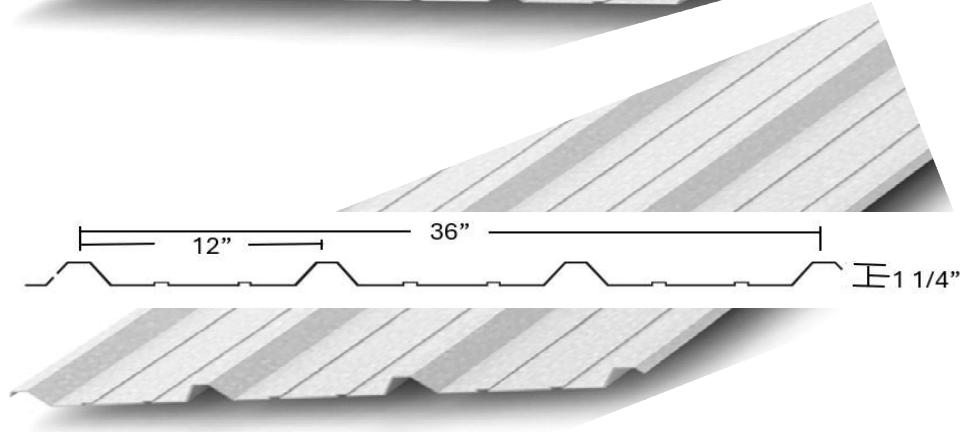

Galvalume
\$3.50
H. Profile
L. Profile



Black
\$3.75
H. Profile



Old Town
Gray
\$3.75
H. Profile

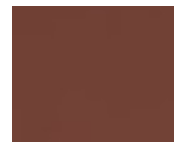

Rustic Red
\$3.75
H. Profile



Polar White
\$3.75
H. Profile



Hawaiian
Blue
\$3.75
H. Profile



Evergreen
\$3.75
L. Profile

* Prices may vary. See store for details. Prices based per linear foot.

TRIM

Available Colors:



Galvalume



Black



Old Town Gray



Rustic Red



Polar White



Hawaiian Blue



Evergreen

Corner - Inside

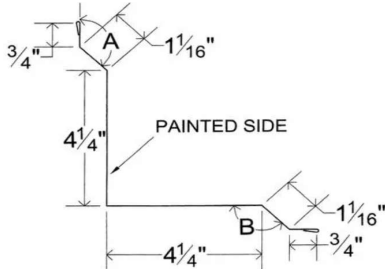

\$32.06

Corner - Outside

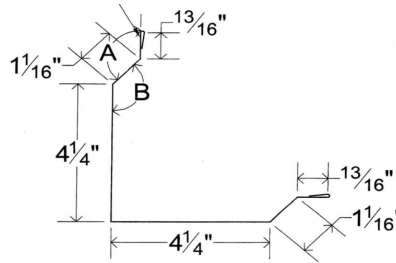

\$30.66

J Flashing

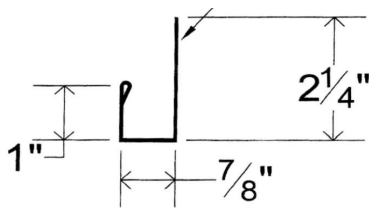

\$22.26

Long Drip Edge

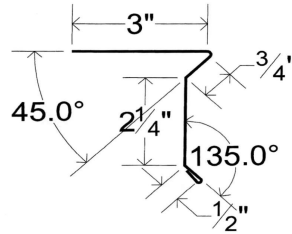

\$29.26

Gable / Rake

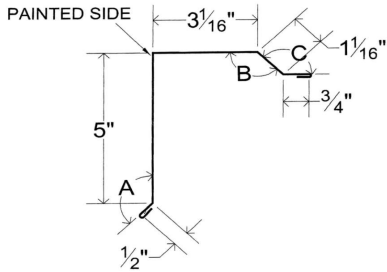

\$29.26

RidgeCap

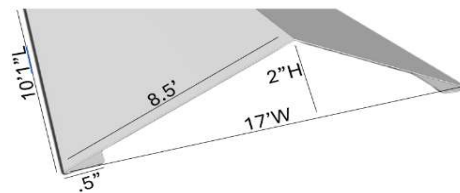

\$30.66

Valley

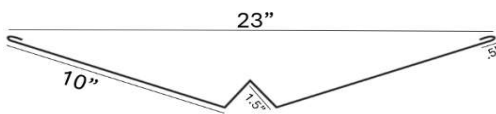

\$30.66

* Pricing is based per 10' section.

SCREWS



Galvalume



Black



Old Town
Gray



Rustic



Polar
White



Hawaiian
Blue



Evergreen

Hex Self Drilling Screw - 1/4 - 14* 7/8



Galvalume	\$37.99	250pc
Hawaiian Blue	\$37.99	250pc
Rustic Red	\$37.99	250pc
Polar White	\$37.99	250pc
Old Town Gray	\$37.99	250pc
Black	\$37.99	250pc
Evergreen	\$37.99	250pc

Hex Self Drilling Screw - #12-14* 1-1/4



Galvalume	\$37.99	250pc
Hawaiian Blue	\$37.99	250pc
Rustic Red	\$37.99	250pc
Polar White	\$37.99	250pc
Old Town Gray	\$37.99	250pc
Black	\$37.99	250pc
Evergreen	\$37.99	250pc

Hex Washer Head - #12-14* 3/4 w/ 14mm washer



Galvalume	\$29.99	250pc
-----------	---------	-------

Hex Washer Head - #12-14* 3/4



w/o washer	\$29.99	600pc
------------	---------	-------

Horn Head Self Drilling Screw - #6-20* 1-1/4



\$24.99	700pc
---------	-------

Rnd Head Self Drilling Screw - #8-18* 1/2



\$39.99	1200pc
---------	--------

Hex Self Drilling Screw - #12-24* 1-1/4



Hawaiian Blue	\$59.99	450pc
---------------	---------	-------

Hex Self Drilling Screw - #10-16* 3/4



\$29.99	600pc
---------	-------

SILICONE & CAULKING TAPE

Silicone-10.1oz

\$5.25



Caulking Tape - 3/8 x 3/32 x 45'

\$4.50



FOAM CLOSURES

R-Panel Inside

\$1.21



R-Panel Outside

\$1.21



A foam closure is a dense foam strip used to seal the joints between metal panels on a roof. They are typically 1 inch thick and 1–2 inches wide, and are cut to match the length of the metal panel.

WELDING GLUE

Epoxy Adhesive

\$8.99

1.67oz



Casting Rubber

17.6oz

Part A

\$24.99

Part B

\$24.99



Epoxy adhesive is a structural adhesive that's made from a mixture of resin and hardener that creates a strong, durable bond.

DOORS / WINDOW / ACCESSORIES



36W x 80H Door

\$195.00



36W x 80H Door w/ diamond window

\$195.00



Walk-in door lock
Can not be sold separate.

\$12.95



24 x 36 Grid Window

\$39.00

ROLL DOOR



9W x 8H	W/ Door Kit	\$715.00
10W x 8H	W/ Door Kit	\$760.50
10W x 10H	W/ Door Kit	\$916.50
12W x 12H	W/ Chain Hoist	\$1,553.50

STRUCTURAL STUDS & TRACKS



362S162-33	3 5/8" Stud	20G	\$1.24
362S162-43	3 5/8" Stud	18G	\$1.60
[^] 362S162-54	3 5/8" Stud	16G	\$1.99
362S162-68	3 5/8" Stud	14G	\$2.48
362S162-97	3 5/8" Stud	12G	\$3.45
600S162-33	6" Stud	20G	\$1.63
600S162-43	6" Stud	18G	\$2.11
[^] 600S162-54	6" Stud	16G	\$2.63
600S162-68	6" Stud	14G	\$3.29
600S162-97	6" Stud	12G	\$4.60
800S162-33	8" Stud	20G	\$1.96
800S162-43	8" Stud	18G	\$2.54
800S162-54	8" Stud	16G	\$3.17
800S162-68	8" Stud	14G	\$3.97
800S162-97	8" Stud	12G	\$5.57
1000S162-43	10" Stud	18G	\$2.97
1000S162-54	10" Stud	16G	\$3.71
1000S162-68	10" Stud	14G	\$4.65
1000S162-97	10" Stud	12G	\$6.54
1200S162-54	12" Stud	16G	\$4.25
1200S162-68	12" Stud	14G	\$5.33
1200S162-97	12" Stud	12G	\$7.51

362T200-33	3 5/8" Track 10 FT	20G	\$9.00
362T200-43	3 5/8" Track 10 FT	18G	\$14.60
[^] 362T200-54	3 5/8" Track 10 FT	16G	\$18.30
362T200-68	3 5/8" Track 10 FT	14G	\$23.00
362T200-97	3 5/8" Track 10 FT	12G	\$32.70
600T200-33	6" Track 10 FT	20G	\$16.40
600T200-43	6" Track 10 FT	18G	\$19.70
[^] 600T200-54	6" Track 10 FT	16G	\$24.70
600T200-68	6" Track 10 FT	14G	\$31.10
600T200-97	6" Track 10 FT	12G	\$47.80
800T200-33	8" Track 10 FT	20G	\$19.70
800T200-43	8" Track 10 FT	18G	\$24.00
800T200-54	8" Track 10 FT	16G	\$30.10
800T200-68	8" Track 10 FT	14G	\$37.90
800T200-97	8" Track 10 FT	12G	\$57.50
1000T200-43	10" Track 10 FT	18G	\$28.30
1000T200-54	10" Track 10 FT	16G	\$35.50
1000T200-68	10" Track 10 FT	14G	\$44.60
1000T200-97	10" Track 10 FT	12G	\$63.50
1200T200-54	12" Track 10 FT	16G	\$40.90
1200T200-68	12" Track 10 FT	14G	\$51.40
1200T200-97	12" Track 10 FT	12G	\$73.70

* Prices may vary. See store for details.
Prices based per linear foot.

* Prices may vary. See store for details.
Prices based per piece.

NON-STRUCTURAL STUDS & TRACKS



^ 162S125-18	1 5/8" Stud	25G	\$0.38
162S125-27	1 5/8" Stud	22G	\$0.57
162S125-30	1 5/8" Stud	20G	\$0.62
250S125-18	2 1/2" Stud	25G	\$0.46
250S125-27	2 1/2" Stud	22G	\$0.68
250S125-30	2 1/2" Stud	20G	\$0.75
362S125-18	3 5/8" Stud	25G	\$0.56
362S125-27	3 5/8" Stud	22G	\$0.82
362S125-30	3 5/8" Stud	20G	\$0.92
600S125-18	6" Stud	25G	\$0.77
600S125-27	6" Stud	22G	\$1.15
600S125-30	6" Stud	20G	\$1.27

^ 162T125-18	1 5/8" Track 10 FT	25G	\$3.60
162T125-27	1 5/8" Track 10 FT	22G	\$5.50
162T125-30	1 5/8" Track 10 FT	20G	\$6.00
250T125-18	2 1/2" Track 10 FT	25G	\$4.40
250T125-27	2 1/2" Track 10 FT	22G	\$6.70
250T125-30	2 1/2" Track 10 FT	20G	\$7.30
362T125-18	3 5/8" Track 10 FT	25G	\$5.40
362T125-27	3 5/8" Track 10 FT	22G	\$8.20
362T125-30	3 5/8" Track 10 FT	20G	\$9.00
600T125-18	6" Track 10 FT	25G	\$7.60
600T125-27	6" Track 10 FT	22G	\$11.40
600T125-30	6" Track 10 FT	20G	\$12.50

* Prices may vary. See store for details.
Prices based per linear foot.

* Prices may vary. See store for details.
Prices based per piece.

CHANNELS & TUBING

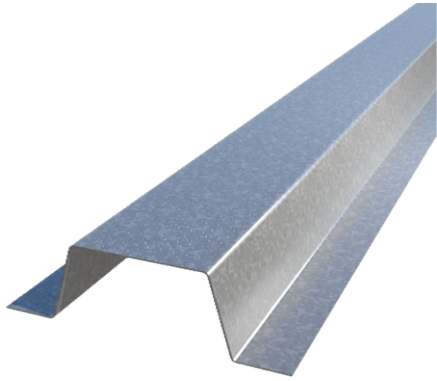

Hat Channel
1 1/2 x 21' 18Ga

\$20.00

7/8 x 21' 18Ga

\$18.00

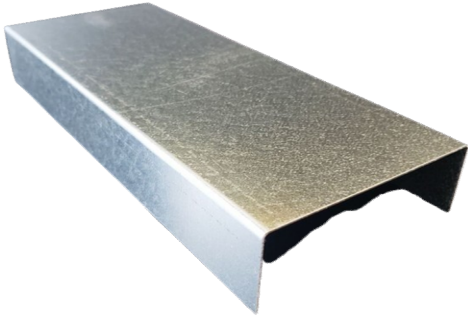

Cee Channel - 10'
1.5" x .5" 16G

\$8.00

Cee Channel - 16'
1.5" x .5" 16G

\$14.00

RAW METAL



Sheet Metal - 48" x 96"

1/8 \$161.10

3/16 \$309.00

Gavanized Sheet Metal

16Ga \$85.50



Diamond Plate

1/4 \$468.00



Angle Iron - 20'

1/8 1 x 1 \$17.04

1/8 1.5 x 1.5 \$24.96

1/8 2 x 2 \$30.24

1/4 1.5 x 1.5 \$42.48

1/4 2 x 2 \$56.16

1/4 3 x 3 \$99.84

3/8 4 x 4 \$127.68



Square Bar - Solid - 20'

.5 x .5 \$18.30



Flat Bar - Solid - 20'

1 x .25 \$18.24

GALVANIZED METAL



11Ga Galvanized tubing - 20'

5/8 x 5/8 \$12.48

3/4 x 3/4 \$18.24

1 x 1 \$22.56

1.25 x 1.25 \$40.80

2 x 2 \$71.04

3 x 3 \$112.32

4 x 4 \$141.12

16Ga Galvanized tubing - 20'

.5 x .5 \$10.80

1/4 Galvanized tubing - 20'

4 x 4 \$218.64

14Ga Galvanized tubing - 20'

1.5 x 1.5 \$36.48

2 x 2 \$44.88

2 1/4 x 2 1/4 \$46.98

2 1/2 x 2 1/2 \$50.98

3 x 3 \$74.64

TEMPORARY FENCING

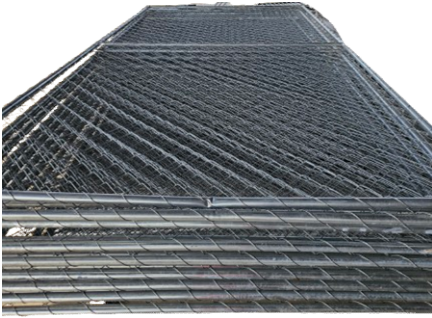

Fence Panel - 6'H x 12'W

\$149.95

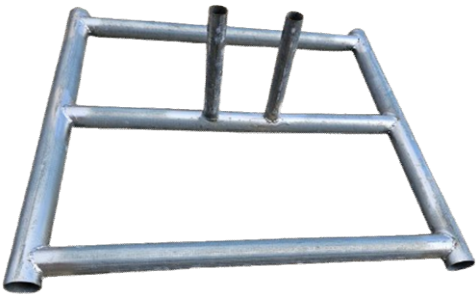

Fence Stand

\$14.99



Fence Bracket

\$2.99

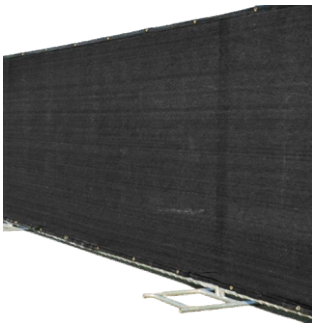

Privacy Screen 6'H x 50'W

\$49.95

*See store for rental details.

BUCKETS



Rust Transform Paint

44 lbs

\$200.00

- * Transforms, converts and replaces existing rust with a dark protective barrier. Prevents future corrosion.
- * Forms a durable protective barrier. Locks out moisture from rain and snow. Protects iron and metal surfaces.
- * Non-toxic and fumeless. Paintable when fully cured.
- * Easy application with roller, brush or airless sprayer.
- * Covers 2000 sq ft



Flexible Slurry

44 lbs

\$150.00

- * Forms a continuous barrier with exceptional adhesion and reduces crack transmission for all surfaces.
- * Can be applied on Concrete, Wood, Stone, Tiles, Metal Aluminum, Interior/Exterior Cladding, and ICF Blocks
- * For interior, exterior, fully submerged in water and below grade applications.
- * Easy application with roller, brush or airless sprayer.
- * Covers 290 sq ft - double coat recommended.



Thermal Insulation

44 lbs

\$150.00

- * Thermal insulating coating is a liquid suitable for application to a surface, that dries or cures to simultaneously form a protective finish and provide resistance to heat flow.
- * Retains heat over twice as long as ordinary emulsion paint.
- * An airless sprayer is the best method for application of the coating.
- * Covers 430 sq ft



ORLEANS STEEL
BUILDING MATERIAL

CLEARANCE
CATALOG



CARPORT



18 x 23 x 11.25
Grey & Blue

~~\$12,420.00~~ \$6,210.00

11.5 x 18 x 11.25
White & Blue

~~\$5,860.00~~ \$2,930.00

Single overhang carport



24.5 x 18 x 11.25
Grey & Tawny

~~\$12,020.00~~ \$6,010.00

Y-Shaped Double carport



13 x 18 x 11.25
Grey & Tawny

~~\$6,700.00~~ \$3,350.00

M-Shaped Single carport



11.5 x 36 x 11.25
Grey & Blue

~~\$11,220.00~~ \$5,610.00

M-Shaped Triple carport